



# WOOJUNG TRB Conveyor Belt



WOOJUNGTRB co., Ltd  
[www.wojungtrb.com](http://www.wojungtrb.com)

# WOOJUNG TRB

## Conveyor Belt

**WOOJUNG TRB** provides high quality products with full care service to our valued customers and continues to be the best brand at industrial conveyor belting market.

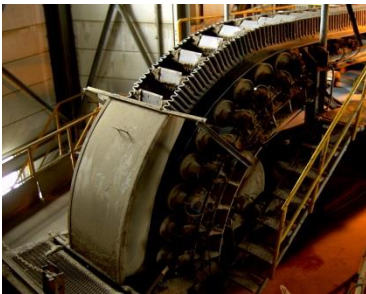

- 1 Introduction & History
- 2 Conveyor Belt
- 3 Steel Conveyor Belt
- 4 Sidewall Conveyor Belt
- 5 Feeder Belt & Coal Feeder Belt
- 6 Filter Belt
- 7 Packaging Information
- 8 Testing Equipment
- 9 Organizational Chart & Certifications
- 10 History
- 11 Cautions in Use of Conveyor Belt

## Introduction

Since its foundation in 1997, WOOJUNG TRB has been committed to the research and development of "high quality functional conveyor belt", one of the core parts to almost all key industries. Thanks to its continued efforts, WOOJUNG TRB is now supplying companies home and abroad with the global standard products such as standard conveyor belts, sidewall conveyor belts, coal feeder conveyor belts, filter belts, and constant conveyor belts. At the same time, the company is making every effort to improve the quality of its products by conducting R&D for various functional conveyor belts.

By achieving sustainable growth WOOJUNG TRB aims to be the most trustworthy company as a professional high quality functional conveyor belt maker who supplies to its customers reliable products and service needed for businesses.



## History

- **1997** WOOJUNG established
- **1999** Manufactured sidewall conveyor belts
- **2001** Registered as a supplier to POSCO
- **2002** Domestically manufactured the sidewall conveyor belts to Sungshin Cement Co. (BANDO)
- **2004** Signed a supply contract of sidewall conveyor belts to POSCO 1 FINEX(DEMO PLANT)
- **2005** WOOJUNG TRB Co.Ltd established
- **2005** Signed a supply contract of sidewall conveyor belts to POSCO 2 FINEX
- **2008** Registered as a qualified service company to 5 affiliated power plants of KEPCO
- **2008** Won ISO-9001 Certification and established the research center
- **2010** Established the 2<sup>nd</sup> factory in Yangsan
- **2010** Exported sidewall conveyor belts to Middle East and Russia
- **2012** Supplied ST630 900W and 650M(2 Lines) to Korea East-West Power in Donghae
- **2013** Signed a supply contract of sidewall conveyor belts to POSCO 3 FINEX
- **2014** Supplied EP500 900W(8 Lines) to Korean Western Power in Pyeongtaek
- **2014** Supplied ST900 1800W and 6,424M(15 Lines) to Korea East-West Power in Dangjin and Honam
- **2015** Supplied seal belt to POSCO
- **2015** All factories moved to brand new buildings in Jangan (Sandan 8 ro 106, Jangan-eub, Gijang-gun, Busan)
- **2015** Won the certification of a qualified supplier of materials and equipment to power plants

## Multi-Layer Conveyor Belt

### Types of materials

Nylon (NN)

- Highly flexible
- Very durable
- Highly bendable

Polyester (EP)

- Low elongation
- Highly resistant to heat
- Highly resistant to moisture

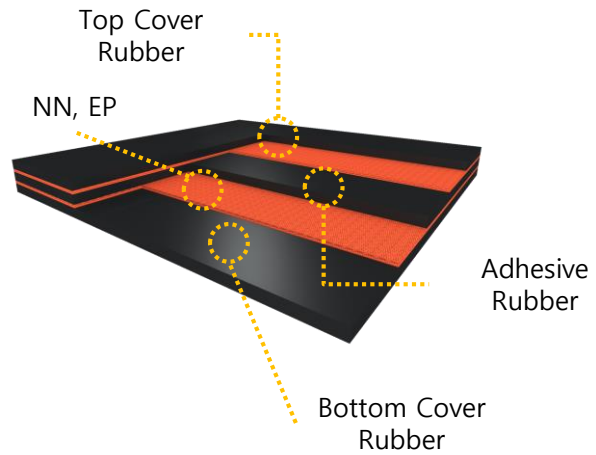

### Structure

Cover rubber consists of the main raw materials such natural or synthetic rubber and protects the carcass. It has the properties resistant to abrasion, heat, oil, and fire, depends on the condition of use. Carcass decides the strength of belt and uses nylon and polyester. To enhance the adhesion between fiber and rubber, adhesives applied to it..

Adhesive rubber uses rubber of low fatigue to stress so as to keeps the adhesive strength between carcass and cover rubber.

※ To better protect carcass, different kinds of rubber with additional protections can be supplied.

### Terminology

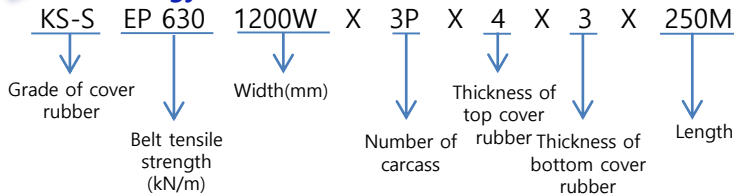

### Specifications

Tensile Strength (kN/m)	Width (mm)	Ply Number	Thickness of top cover rubber(mm)	Thickness of bottom cover rubber(mm)
315	400~ 600	3	3.2~4.8	1.6~2.4
400	400~ 900	3~4	3.2~4.8	1.6~2.4
500	400~1200	3~5	3.2~4.8	1.6~3.2
630	500~1600	3~5	3.2~6.4	1.6~3.2
800	750~1600	4~5	4.8~8.0	2.4~3.2
1000	750~2200	4~6	4.8~8.0	2.4~3.2
1250	750~2200	5~6	4.8~8.0	2.4~3.2
1500	750~2200	5~6	4.8~8.0	2.4~3.2

※ As for other specifications, please contact us.



▶ **Capability of Cover rubber**

Category			Standard			Abrasion-resistant	
			KS-L	KS-G	KS-S	KS-A	SA
Tensile Test	Before aging	Tensile Strength (MPa)	Min. 8	Min. 14	Min. 18	Min. 14	Min. 18
		Elongation(%)	Min. 300	Min. 400	Min. 450	Min. 400	Min. 450
	After aging	Tensile Variation(%)	±40	±30	±25	±25	±25
		Elongation Variation(%)	±40	±30	±25	±25	±25
Ozon Test					No crack	No crack	No crack
Abrasion Test(mm <sup>3</sup> )						Max. 150	Max. 80

▮ **Standard & Abrasion-resistant Conveyor belts**

When lots of remained cake on the roller or serious abrasion by conveyed material are caused, the standard conveyor belts ( KS – L, G ) might not last long enough for its expectancy. In this case, using abrasion-resistant belts is advised to raise conveying efficiency.

▮ **Heat-resistant Conveyor belts**

▶ **Capability of Cover rubber**

Product No.	H-120	H-150	H-180
Usage	Max. 120°C	Max. 150°C	Max. 180°C

In case of conveying material' temperature is higher than 60°C, we recommend to use heat-resistant belt. It is important to use right belts, since level of damage to the cover rubber differs based on the temperature and figures of conveyed material. In particular, special care should be taken to the relation of material's temperature and the temperature of belt surface. Temperature difference can be caused not only by material's figure, belt length, belt speed, operating conditions and operating time, but also the difference of heat conduction from material to belt surface..

▮ **Oil-resistant Conveyor belt**

Oily conveying material spreads grease on the cover rubber, causing it swelling, flaking, reverse trough phenomenon to cover rubber, thus eventually it damages belts. In case of oily material, using oil-resistant conveyor belt are advised.

▮ **Fire-resistant Conveyor belt**

Fire-resistant conveyor belt is mainly used at mills, fertilizer plants, power plants, and coal mines, where damages can be minimized in the event of fire.

※ As for other purposed conveyor belts, please contact us.

## Steel Conveyor Belt

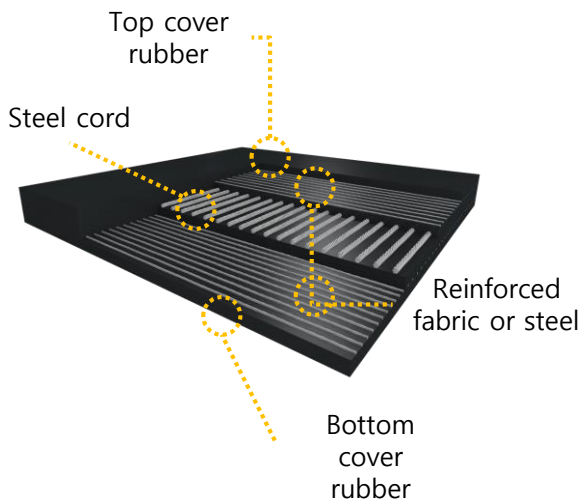

### Features

- By using high carbon steel cord as carcass, it has ultra strength which synthetic fabrics can't produce.
- Take-up distance can be reduced by keeping low elongation as synthetic fabric.
- In case of using standard joint method, the endless part preserve strength same or higher than main body by improving the joint area efficiency of junction point.
- Superior in flexibility against strength
- Suitable to long distance and large material

### Structure

- Cover rubber protects carcass
- Steel cord decides the strength of belt and adhesives applied to it, to reinforce adhesive strength with layer of rubber.
- Adhesive rubber uses rubber of low fatigue to stress so as to keeps adhesive strength against the sustaining flexibility to steel cord.

※ Featured belt inserted with reinforced cord to prevent belt tear caused by impacts of material falling or hits by foreign materials can be supplied.

## ▶ Standard Specifications

Type	Cord Diameter(mm)	Cord Pitch (mm)	Head Pulley Dia.(mm)
ST 500	2.9	12.5	500
ST 630	2.9	10	500
ST 800	3.6	12	630
ST 1000	4.9	12	630
ST 1250	4.8	14	630
ST 1600	5.5	15	800
ST 2000	5.5	12	800
ST 2500	7.1	15	1000
ST 3150	7.9	15	1250
ST 3500	8.4	15	1250
ST 4000	8.9	15	1250
ST 4500	9.6	16	1400
ST 5000	10.7	17	1600
ST 5400	11.2	17	1600

※ As for any inquiries about the belts with reinforced fabric and cord, and other specifications, please contact us.

## ▶ Cord Structure

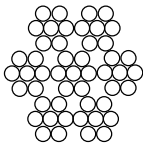

7 X 7  
Applicable to low strength

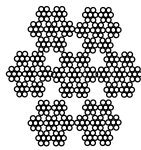

7 X 19  
Applicable to high strength

## ▶ Terminology

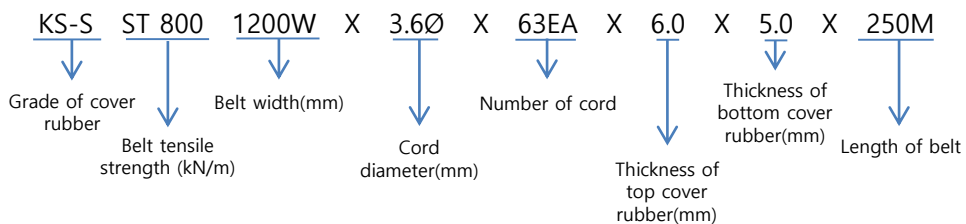

## FINEFLEXWALL® Conveyor Belt

FINEFLEXWALL Conveyor Belt to which sidewall and cleat are attached, enables vertical transportation of conveyed material.

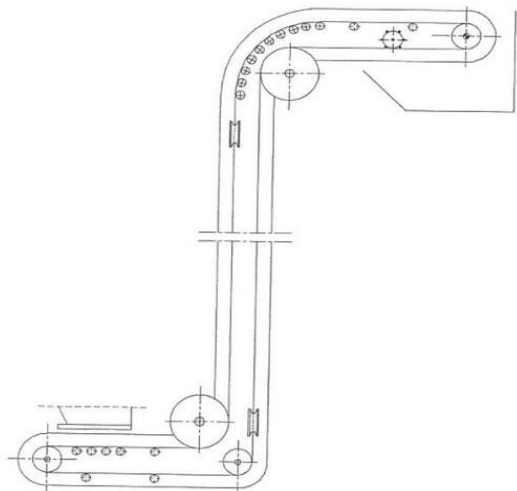

### ► Features of FINEFLEXWALL® Conveyor Belt

- Give better high moving strength and reduced width of conveyor belt due to bigger loading area.
- Steep angle and vertical transportation minimizes equipment area.
- Skirt board is not necessary to prevent the falling of material.
- Easy to change tilt angle
- Ordinary roller is usable, lower maintenance cost

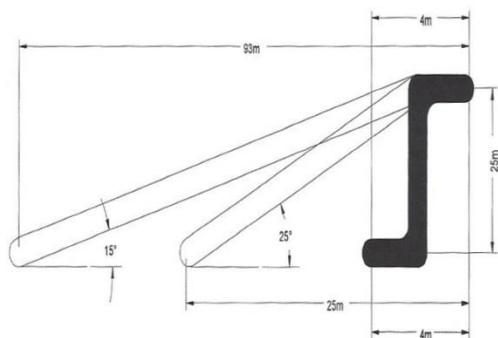

### ► Minimize Equipment Area

Adjustment of tilt angle can be minimized conveyor installment area.

In case of ordinary conveyor belt, several lines need to be installed and the equipment area should be enlarged.

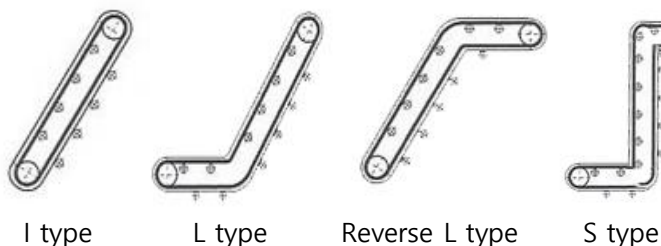

### ► Shapes of Line

Different line shapes can be selected depending on other equipment's layout surrounding it.

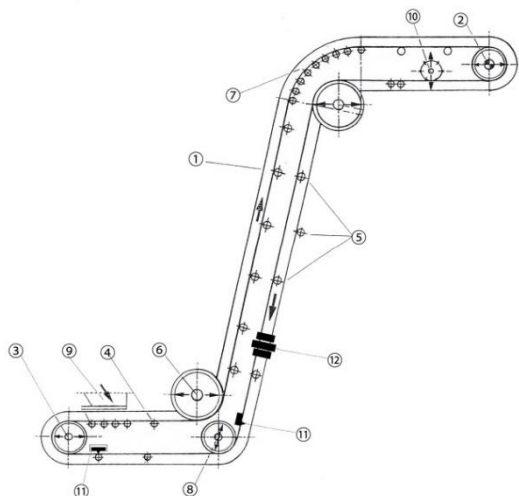

### ► Names of Equipment

No	Name	No	Name
1	Sidewall Conveyor	7	Bend Pulley
2	Head Pulley	8	Bend Pulley
3	Tail Pulley	9	Shute
4	Carrier Roller	10	Beat Cleaner
5	Return Roller	11	Scraper
6	Disk Pulley	12	Side Roller



## ► Shape and Name

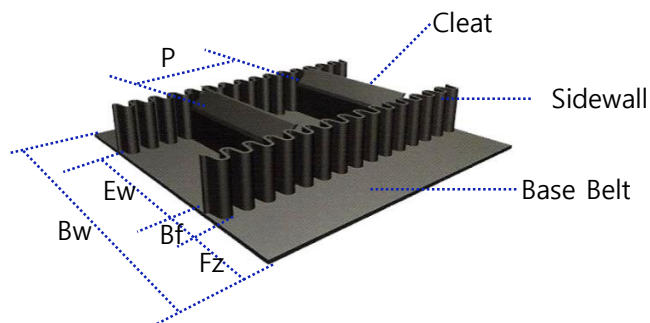

- **Base Belt** Main Belt
- **Bw** Belt Width
- **Ew** Efficient Width
- **Fz** Free Zone
- **Cleat** Cleat
- **P** Cleat Pitch
- **Sidewall** Sidewall
- **Bf** Sidewall Bottom Width

## ► Structure of Base Belt

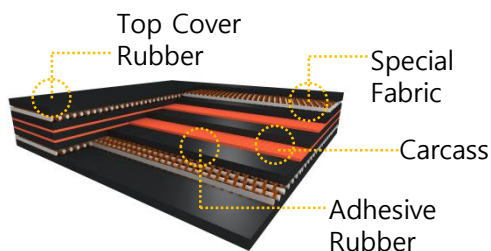

### Belt Terminology

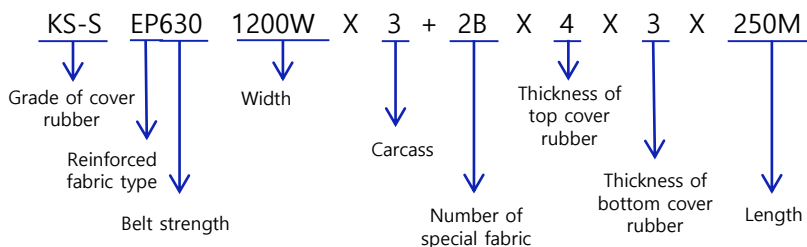

## ► Base Belt Type

Product Code	Cross-section Structure	Total Tensile Strength (kN/m)	Thickness of Cover Rubber (mm)	Thickness of Belt (mm)	Weight (kg/m <sup>2</sup> )	Minimum Pulley Dia. (mm)
XE		315/2	3 x 2	7.8	9.4	315
XOE		315/2	4 x 2	10.5	12.6	315
		500/3	4 x 2	11.8	14.2	450
XDE		315/2	4 x 2	12.2	14.4	315
		500/3	4 x 2	13.5	16.0	450
		630/4	4 x 2	14.8	18.0	550
		800/5	4 x 2	16.1	19.3	700
		1000/6	4 x 2	17.4	20.9	800
		1250/6	4 x 3	19.0	22.8	1000
		1500/6	4 x 3	21.5	25.8	1400
XST		1500~4500	Please contact us when steel cord is used as carcass or reinforced fabric.(Maximum width is 2200mm)			

※ Base Belt Type is the standard specification of the company and subject to change according to the layout and shape of line.

## ► Sidewall Specifications

Unit: mm

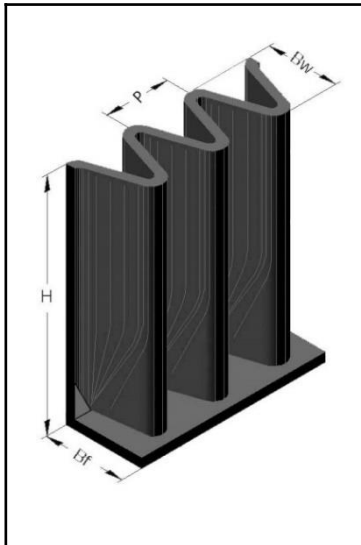

Type	H	Bf	Bw	P
S	40	30	35	25
	80	50	40	45(40)
	100	50	40	45(40)
	120	50	40	45
	120	80	70	60
	160	75	65	63
	180	75	65	63
	200	75	65	63
	240	75	65	63
	280	75	65	63
ES	300	90	80	75
	400	100	90	83
	500	100	90	83

※ The above is the standard specifications and 40H~80H is only rubber product without inserting reinforced fabric.

## ► Cleat Specifications

Unit: mm

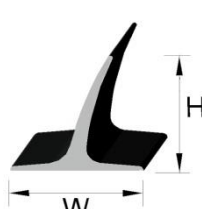
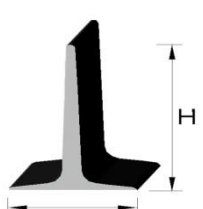
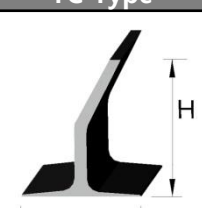
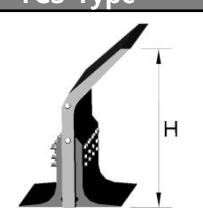
C Type	H	W	T Type	H	W
	70	80		90	100
	110	110		110	110
	120	140		120	120
	140	140		140	140
	150	150		180	180
	180	180			
TC Type	H	W	TCS Type	H	W
	110	100		220	180
	140	140		280	230
	180	160		360	230
	220	180		460	250
	230	230			

※ The above is the standard specifications and TCS Type uses special reinforced fabric.

## ► Types of Grade

- **General** is used to convey ordinary material which doesn't require any particular features.
- **Abrasive Resistance** is used to convey material that has heavy attachment to it or that needs abrasion resistant feature. It has an advantage in terms of cost and maintenance.
- **Heat Resistance** is used when the temperature of conveyed material is higher than 60°C.
- **Non Flammable** is used at mills, fertilizer plants, power plants, and coal mines, to minimize the damages by fire.
- **Oil Resistance** is used to convey oily material to prevent deformation of belts caused by oil.
- **Chemical** is used to convey material with chemicals such as medicine, pulp, and pottery.

## Feeder Belt

Feeder Belt has Sidewall attached on the both edge of conveyor belt. It prevents the overflow of conveying material, so it maintains clean operating conditions. It is highly effective to convey material with much moisture.



➤ Example of Falling Materials

### Specifications of Feeder Belt

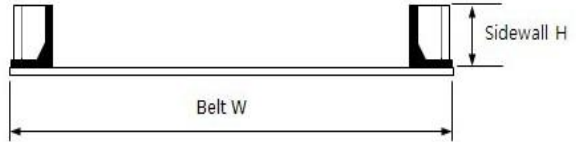

Unit: mm

No	Belt Width	Sidewall Height
1	400~800	40~80
2	900~1200	80~120
3	1300~1600	80~200
4	1700~2200	120~200

#### Main Contractors

- Steel maker • Cement Manufacturer
- Power Plant • Chemical Company

## Coal Feeder Belt

Coal Feeder Belt is used at cement manufacturers, steel makers and power plants. It transports material such as coal and limestone by quantity. One-pieced flange on the both edge prevents the overflow of material and Center V-Guide in the bottom keeps stable operation of belts.

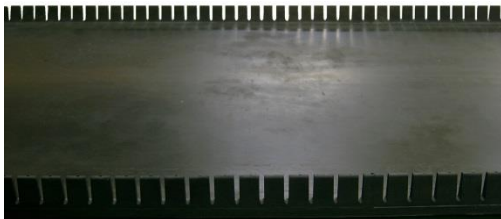

### Specifications of Coal Feeder Belt

Unit: mm

Belt Width	Flange Height	Center V-Guide	
		Width	Height
838	36	32	10
914			
1067			



#### Flange Types

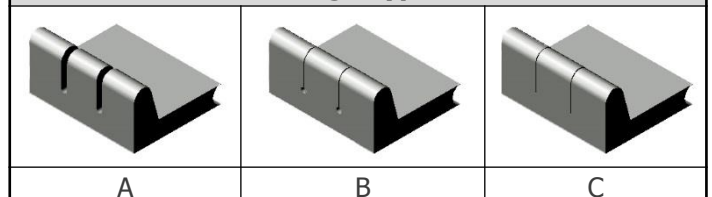

#### Main Contractors

- Steel maker • Cement Manufacturer
- Power Plant

## Filter Belt

Filter Belt is supplied to mechanism industry where needs continuous massive filtering. It is used to separate slurry from liquid material.



### Features of Filter Belt

- Correct measure when planning and installment
- High effective to separate solid from liquid.
- High quality cover rubber is applied (Resistant to chemical, abrasion, heat )

### Main Contractors

- Power Plant / Chemical Company / Paper Maker

### Specifications of Filter Belt

Unit: mm



Belt Width	Grooving				Height of Curbing
	Width	Depth	Pitch	Length	
800	13	11	20	600	100
1200	13	11	20	1000	100
1600	13	11	20	1400	130
2400	13	11	25	2200	130
3200	19	18	26	3000	130
4200	19	18	26	4000	130

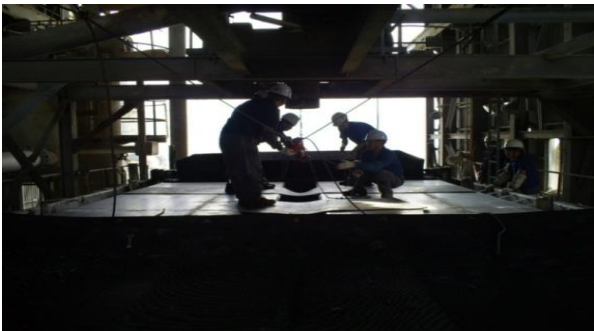

### Specifications of Curbing

Unit: mm

Height	Type		
	A	B	C
65	○		
100		○	
125			○
130		○	
Shape			





## FINEFLEXWALL® Conveyor Belt

### ▶ Wooden Box Packing Type



### ▶ Steel Box Packing Type



## Conveyor Belt

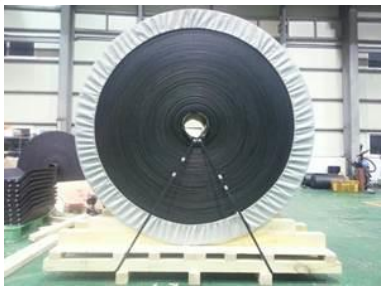

## Filter Belt

### ▶ Open Type



### ▶ Endless Type



## Feeder & Coal Feeder Belt





## Test Equipment



### Rheometer



Rheometer is a device to measure hardening of rubber. It measures sharing stress by spinning torque of the subjects under particular temperature and pressure.

( It measures optimal cure condition of rubber. )

### Tester for Aging



The equipment causes aging effects to rubber by heating test piece rubber in a certain temperature, (It helps analyze contraction, tensile strength, elongation, tearing strength of aged piece by comparing it to before aging.)

### Universal Tensile Tester (UTM)



The machine measures various resistance which might be caused by material transformation. It converts the mechanical and physical properties of test piece into data to analyze tensile strength, elongation, and adhesive strength.

### DIN Abrasion Tester

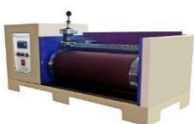

The equipment evaluates the durability of abrasion, and measures abrasion index, friction amount of test piece by comparing it with standard products in the same condition.

## ▶ Tester for Sidewall Fatigue to Stress



The equipment measures and improves the durability of sidewall by conducting adequate tests to prevent mal-functioning during operation.



## ▶ Test Roll

The equipment tests physical characters of new combination of materials before massive production.

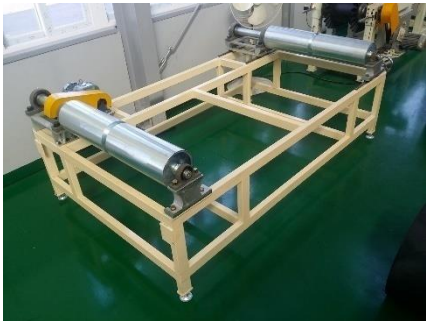

## ▶ Tester of Performance of Coal Feeder & Feeder Belt

The equipment tests the length difference of right and left part of belt after Endless, and operational stability

## ▶ Non-destructive Tester

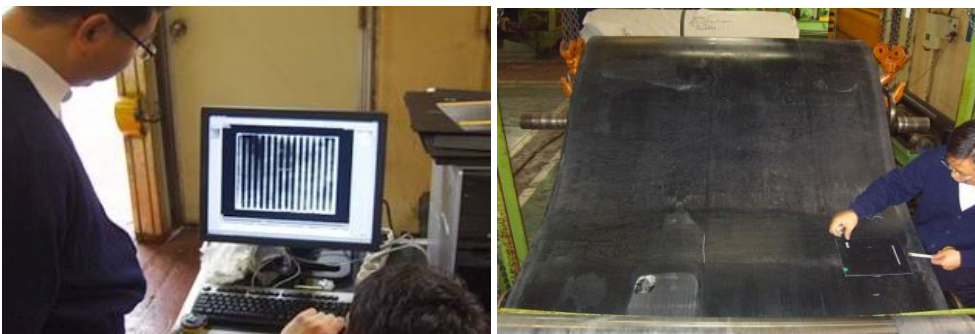

The equipment checks the array of steel cords with X-ray, to secure the stability of steel cord conveyor belt.

## Organizational Chart

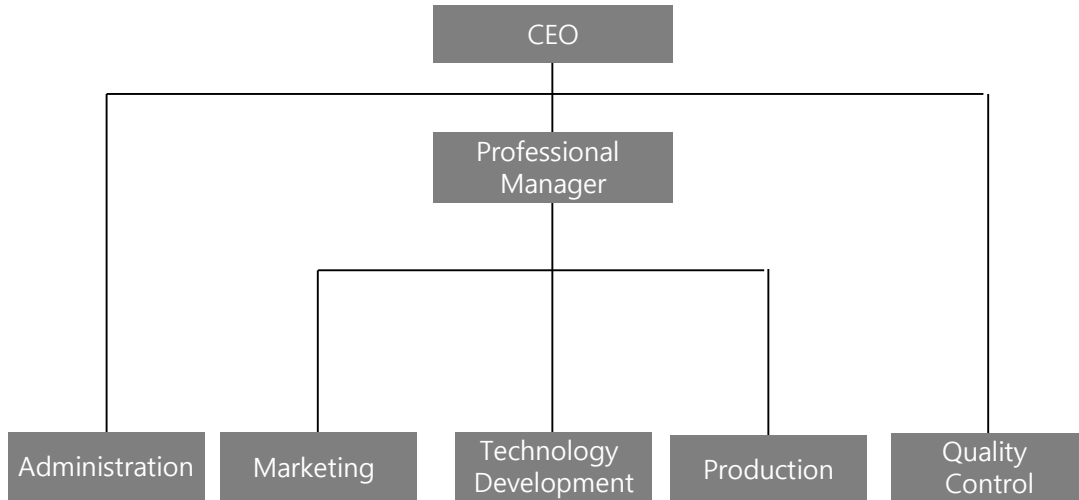

## Certifications

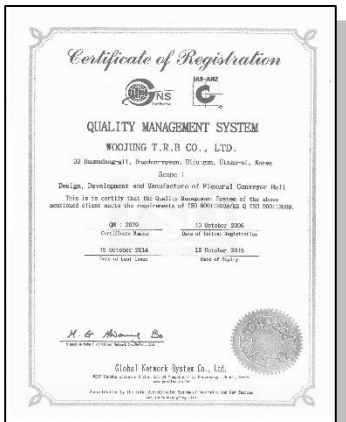

ISO 9001 Quality Management System

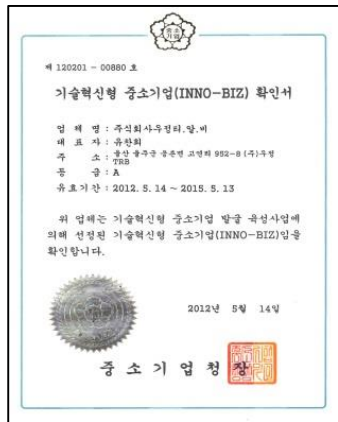

Innovative Business



Patent for Filter glooving Machine



Patent for Vertical Belt Manufacturing Method (1)



Patent for Vertical Belt Manufacturing Method (2)

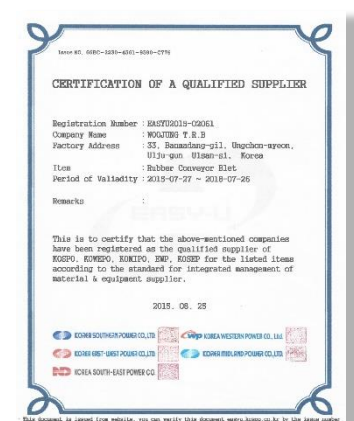

License for Power Plant Equipment Supplier



## History of WOJUNG TRB by Year

1) Manufactured special fabric belt (1997)



2) Installed fenders (2000)



3) Filter belt grooving (2002)



4) Supplied vertical BC to POSCO (2003)  
1000W X 210M



5) Supplied to Sunshin Cement Co (2004)



6) Supplied vertical BC to POSCO (2005)  
ST4000 1600W X 250M



7) Supplied filter belt 4200W (2007)



8) Supplied filter belt 4200W (2008)



9) Supplied filter belt to Ulsan power plant (2010)



10) Supplied 3F vertical BC to POSCO (2011)



11) Domestically manufactured HITACHI(BANDO) (2013)



12) Supplied ST900 1800W and others to Korea East-West Power (2014)



### 2012년도 상반기 우수중소기업인상 시상식

2012. 7. 10(화) 부산·울산지방중소기업청



Since its establishment with youth and ambition in 1997, WOJUNG TRB has continued to manufacture and install functional conveyor belts. Thanks to successful supply of high quality products to steel makers with its accumulated knowhow, WOJUNG TRB was selected as 'the Best Small and Medium-sized Company' in the first half of 2012 and later in January of 2014, it was chosen as 'a Small but Strong Company' by the Ministry of Employment and Labor. WOJUNG TRB will make unceasing effort to enhance its brand image not only in Korea but also all over the world.

## Routine Maintenance and Cautions

**⚠ Caution** Belts should be inspected as to the following checkpoints before using them. Appropriate actions should be taken for any abnormal conditions.

### ▶ Routine Maintenance

Category	Checkpoint	Corrective Actions
Routine Maintenance	Damages or wear of belt body	Repair or replacement
	Peeling or damage on joining parts	Repair and rejoining or replacement
	Poor roller rotation and wear	replacement
	Foreign materials attached to pulley or roller	Removal of foreign materials or replacement (quality change)
	Abnormal take-up action parts	Maintenance
	Skirt and cleaner damages	Maintenance
	Shute damages	Maintenance

### ▶ Cautions in Operation

Category	Checkpoints
Cautions in Operation	Install a shield wall or safety cover to prevent the accidents of being squeezed between the belt and equipment.
	Wear protective gear to prevent Install a detection device on equipment for emergency stop situation.
	Do not step on or touch the belts; Operators might be squeezed or fall.
	Check power switch, emergency stop device before starting operation to prevent any emergency.
	Use a sound device to detect whether or not the belt is operating.
	Observe maximum load limit to prevent any damage to the belt.
	Ensure transport materials are not spilt over the belts sides. It may cause damage to the belt when material is squeezed in the equipment.
	Install a device on equipment for preventing reverse rotation, meandering detection, Pulley rotation detection, emergency stop to protect the belt and line.
	Immediately stop and check the line in the event of any irregular noise or malfunctioning.
	No maintenance or repair during operation
	In case of stopping operation, install a safety device on power switch and attach a note of the reason.



## Routine Maintenance for Sidewall Conveyor Belt

**⚠ Caution** Belts should be inspected as to the following checkpoints before using them. Appropriate actions should be taken for any abnormal conditions. .

NO.	Item	Checkpoint	Corrective Actions
1	Belt	Discolor of Cross Rigid Fabric in upper and lower part of the belt or tear in the directions of width/length	Belt replacement
		Damage to belt surface or peeling in the part of Free Zone or belt edge	Repair or replacement
		Attachment of foreign material to belt surface	Maintenance (removal of attachment)
		Serpentine motion	Maintenance
2	Sidewall Cleat	Tear or detachment of Sidewall and Cleat	Repair or replacement
		Abrasion of Sidewall and Cleat	Maintenance and inspection
		Detachment of fastening bolts on Sidewall and Cleat	Maintenance (fasten or attach bolts)
		Poor rotation of Roller	Repair or replacement
3	Equipment	Detachment or partial abrasion on the rubber of Head and Disk Pulley	Repair or replacement
		Attachment of foreign material to Roller and Pulley	Maintenance (removal of attachment)
		Transportation of irregular material(Shute)	Maintenance
		Unusual noise during operation	Maintenance

## Cautions when Splicing Belts

**⚠ Caution**

1. Belts should be spliced on even surface according the strict procedures to ensure safety.
2. Be careful in performing work or handling tools at high or dangerous line.
3. Be aware of ignition in the workplace.
4. Avoid direct sunlight and remove moisture or dust around the joint area before splicing belts.
5. Ensure to give sufficient ventilation when rubber bond or solvent is used.
6. Only pre-approved joint materials are allowed for splicing belts. Check out valid period of splicing materials.

**Conveyor Belt**  
**WOJUNG TRB**  
Technical Rubber Belt



**WOJUNG** **WOJUNG TRB**

Contacts 106 Jangan Sandan 8ro, Jangan eub, Gijang-gun,  
Busan, 46034 South Korea  
Tel. 82 51 724 7330 Fax. 82 51 7247332  
E-mail : [wojungtrb@naver.com](mailto:wojungtrb@naver.com)

- ※ The contents are subject to change without notice.
- ※ Interested buyers are advised to contact us for further details and specifications.
- ※ All rights reserved. Any unauthorized reproduction or copying is strictly prohibited.